

N.º 375

Rosários 4[®]

Spring/Summer Collection

Spring/Summer Collection

NEON BAG

DESIGN:

Marta Ovelha
@marta_ovelha



CORRIDINHO



97% COTTON | 3% POLYESTER



n.º 375

Spring/Summer Collection

P. 2

NEON BAG



CORRIDINHO



97% COTTON | 3% POLYESTER

LIGEIRO/ LIGHT
LIGERO



50g
(1,75 oz)

130
METROS
METRES
142
YARDS

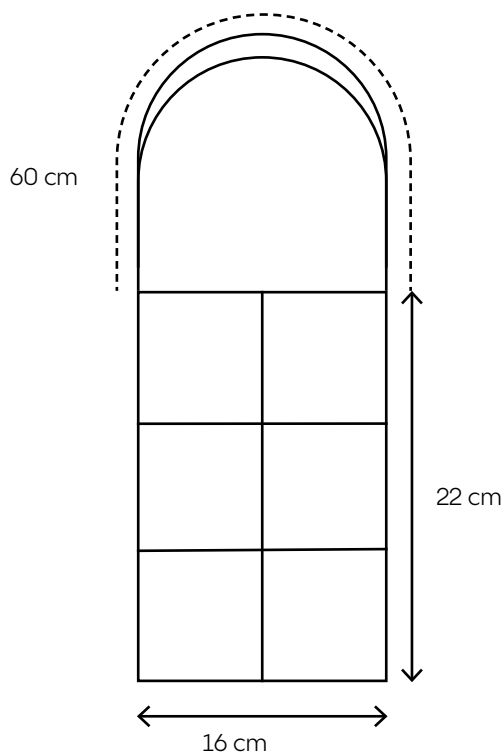

YARN

2 balls of **Corridinho** from Rosários 4, **color 37** (97% cotton, 3% polyester; 50g/130m) – **color A**.

1 ball of **Corridinho** from Rosários 4, **color 39** (97% cotton, 3% polyester; 50g/130m) – **color B**.

GAUGE

Granny Square with 3 rows - 7x7 cm, washed and blocked.

NEEDLES

Crochet hook 3,5mm.

FINAL MEASUREMENTS

See final measurements of the garment in the sizing chart.

Summer bag in Grannies "Half and half", halves of crochet squares, worked together. Zigzag stitching and sheel handle.



INSTRUCTIONS

SPECIAL STITCHES

Zigzag seam stitch: place the grannies side by side and with the crochet hook, join the yarn under the granny, catching the two loops of the stitch, insert the needle from top to bottom in the other granny, pull the yarn and close with a slip stitch, insert the needle from top to bottom in the other granny, pull the yarn and close with a slip stitch, continue in this way until the seam is finished.

Work according to chart A or the following written instruction:

With color A, work magic ring.

Round 1 (RS): 4 ch, 3 dc, 2 ch, 3 dc, 1 ch, 1 dc. Adjust the magic ring.

Round 2 (WS): 4 ch, 3 dc, 1 ch, (3 dc, 2 ch, 1dc), 1cht, 3 dc, 1 ch, 1 dc.

Round 3: 4 ch, 3 dc, 1 ch, 3 dc, 1cht, (3 dc, 2 ch, 3 dc), 1 ch, 3 dc, 1ch, 3 dc, 1ch, 1 dc. Cut the yarn and bind off.

To work the second half of the granny, turn the work so that the top of the triangle is down and the center of the magic ring is up.

Work according to chart B or the following written instruction:

With color B, join the yarn in the center of the magic ring.

Round 1 (RS): 3 ch, 1 sc (worked in the top of the dc horizontal stitch), turn work, 1 ch, (3 dc, 2 ch, 3 dc), 1 sc, 1 dc worked in the center of the magic ring, join with 1 sc hugging the horizontal dc.

Round 2 (WS): 2 ch, 1 sc (worked at the top of the dc horizontal stitch), turn the work, 1 ch, 3 dc (worked over the ch of the previous round), 1 ch, (3 dc, 2 ch, 3 dc), 1 ch, 3 dc, 1 ch, 1 dc (worked over the ch of the previous Round, join with 1 sc hugging the horizontal dc.

Round 3: 2 ch, 1 sc (worked at the top of the dc horizontal stitch), turn the work, 1 ch, 3 dc (worked over the ch of the previous round), 1 ch, 3 dc, (3 dc, 2 ch, 3 dc), 1 ch, 3 dc, 1 ch, 3 sc, 1 ch, 1 dc (worked over the sc of the previous Round, join with 1 sc hugging the sc that is horizontal. Cut the yarn and bind off.

Repeat the instruction from the beginning 11 more times (12 grannies).

Join grannies, contours and seams:

With color A - with the RS facing, join one by one with a zigzag seam until you have a row of 6 grannies. Repeat with the remaining grannies; (2 rows of 6 grannies).

Outline the 2 rows of grannies in sc.

Join the 2 rows of grannies vertically with a zigzag seam.

Fold in half, leaving 6 grannies from the front and 6 grannies from the back, sew the sides. Start sewing at the base of the bag, work as follows, 1 sc, 1 ch, 1 sc (36 sts). Cut the yarn and bind off. Repeat on the other side.

Outline the opening of the bag as follows, 1sc, 1 ch, 1sc (52 sts).

STRAP

In color A, cast on 2 chains.

Row 1: in 2nd chain, 5 sc, turn.

Row 2: in 1st chain, 5 sc, turn.

Repeat row 2 for 78 more rows, i.e. ending with row 80.

Weave in all ends with tapestry needle. Wash the piece thoroughly with a mild detergent. Block the piece, adjusting to the final measurements.

CHART A

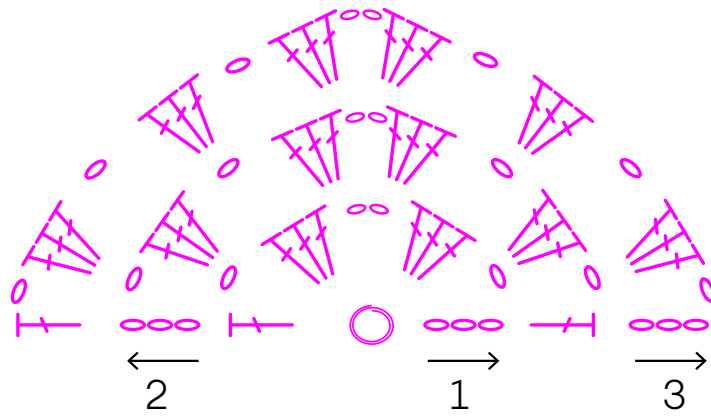
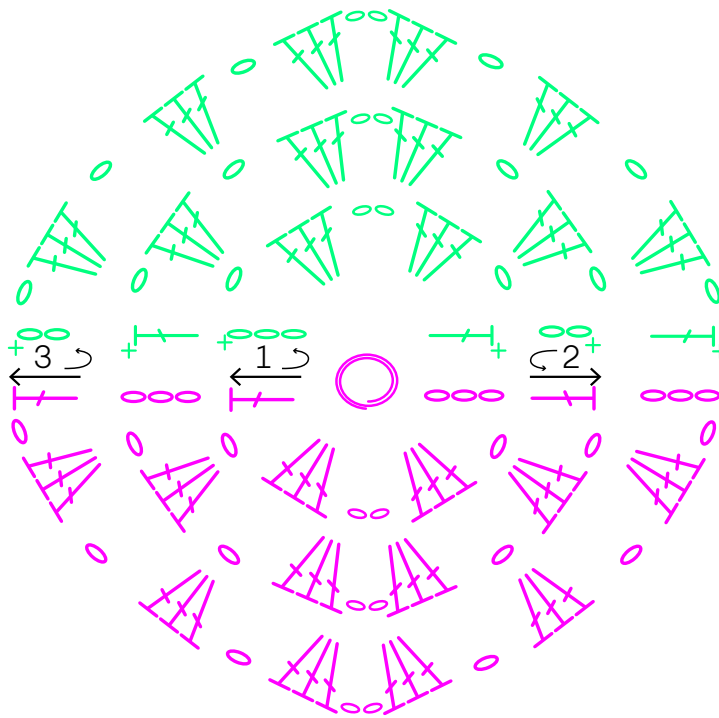





CHART B



-  Magic Ring
-  Chain
-  Single crochet
-  Double crochet

ABBREVIATIONS

- ch:** chain
sl st slip stitch
sc single crochet
dc double crochet
RS right side.
WR wrong side.
st/s stitch/stitches.
rnd/s round/rounds



I would love to see the progress of your work and the final garment, please share your photos on social media using:

#NEONBAG #ROSARIOS4 #ROSARIOS4CORRIDINHO

YARN

Where can I find this yarn? Send an email to:

geral@rosarios4.com

Rua das Grutas, 13
Apartado 123
2485-059 Mira de Aire
PORTUGAL
Tel. +351 244 447 300
info@rosarios4.com

www.rosarios4.com



Rosários 4®